

Copying of this document and giving it to others and the use or communication of the contents thereof, are forbidden without express authority. Offenders are liable to the payment of damages. All rights are reserved in the event of the grant of a patent or the registration of a utility model or design.

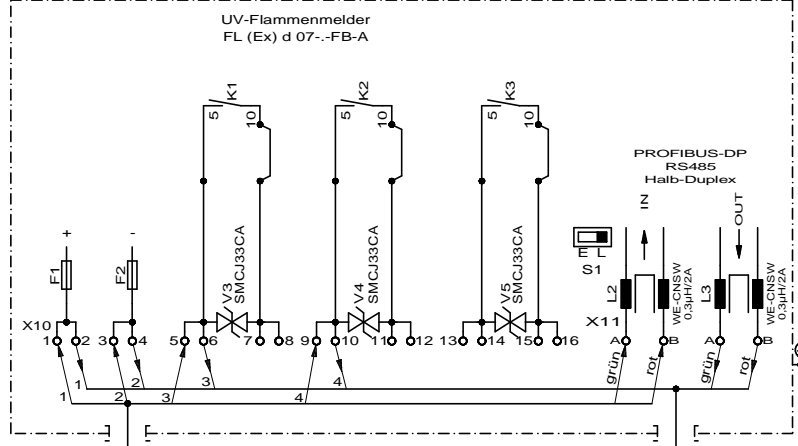

Meßwerte Meldelinie:
 Betriebsbereit = 3K3
 Sammelstörung = OL
 Feuersalarm = 564E

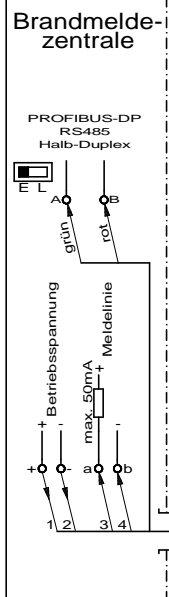
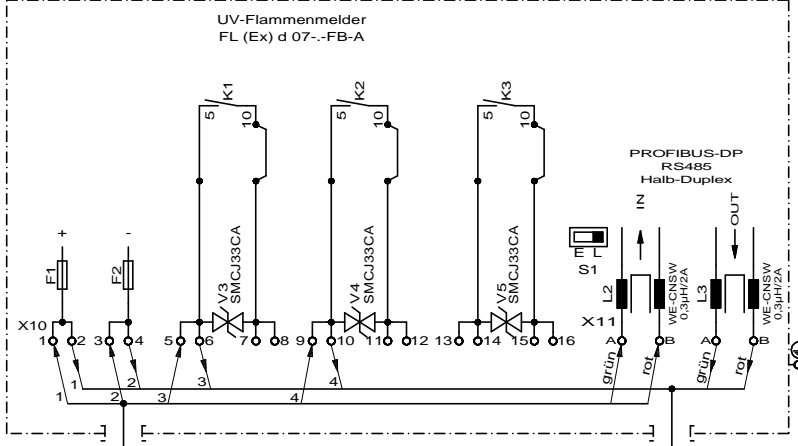
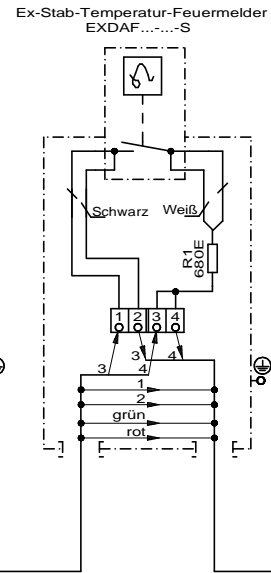

PROFIBUS Hybridkabel
 1 x 2 x 0.64 Ø + 4 x 1.5 mm²

Weitergabe sowie Vervielfältigung dieser Unterlage, Verwertung und Mitteilung ihres Inhaltes nicht gestattet, soweit nicht ausdrücklich zugestanden. Zuwiderhandlungen verpflichten zu Schadensersatz. Alle Rechte für den Fall der Patenterteilung oder GM-Eintragung vorbehalten.

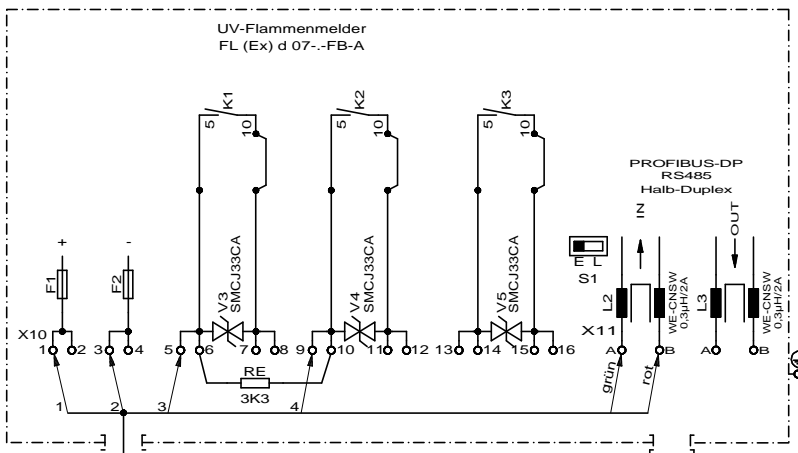
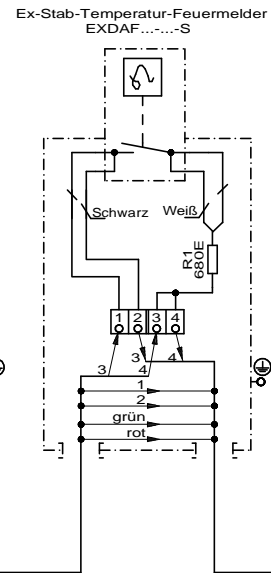
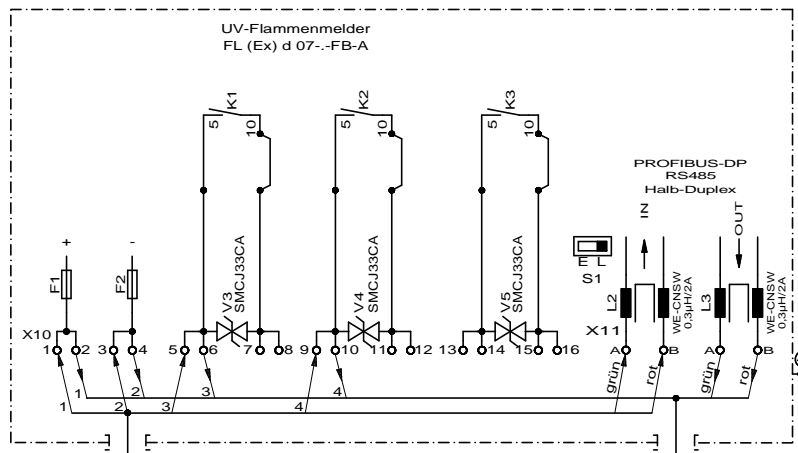

				Datum	06.09.2013	flamtron Feuermeldeanlagen	EGON HARIG APPARATEBAU 22113 Oststeinbek	UV-Flammenmelder FL (Ex) d 07--FB-A Beispiel Meldelinien und PROFIBUS-DP / Klemmenplan	FL_Ex_d_07 ⁽³⁾	3.09262.12	= + Blatt 1 1 Bl.
				Bearb.	H.Bolzmann						
				Gepr.	U.Mathias						
Zustand	Änderung	Datum	Name	Norm	Urspr./ Ers. f./ Ers. d.						